

Installation Manual

L.AL.07(C)

AL-KO AMC Chassis, 2010 → Single and Tandem rear axle

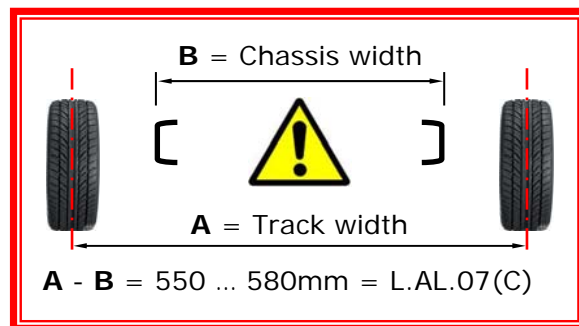
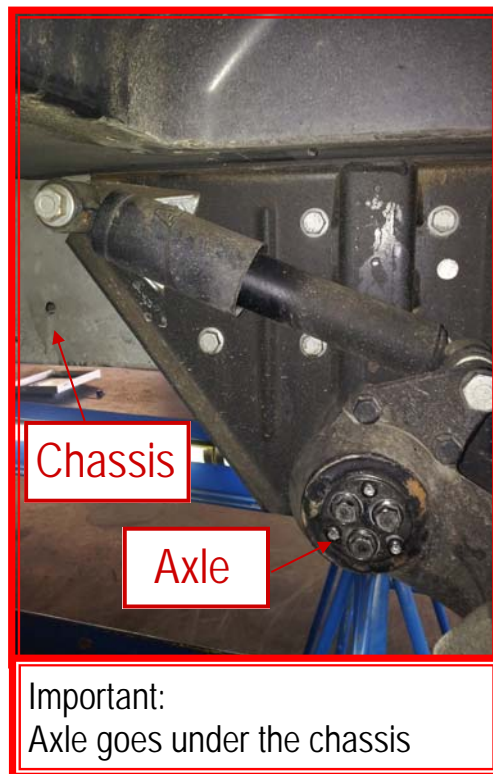
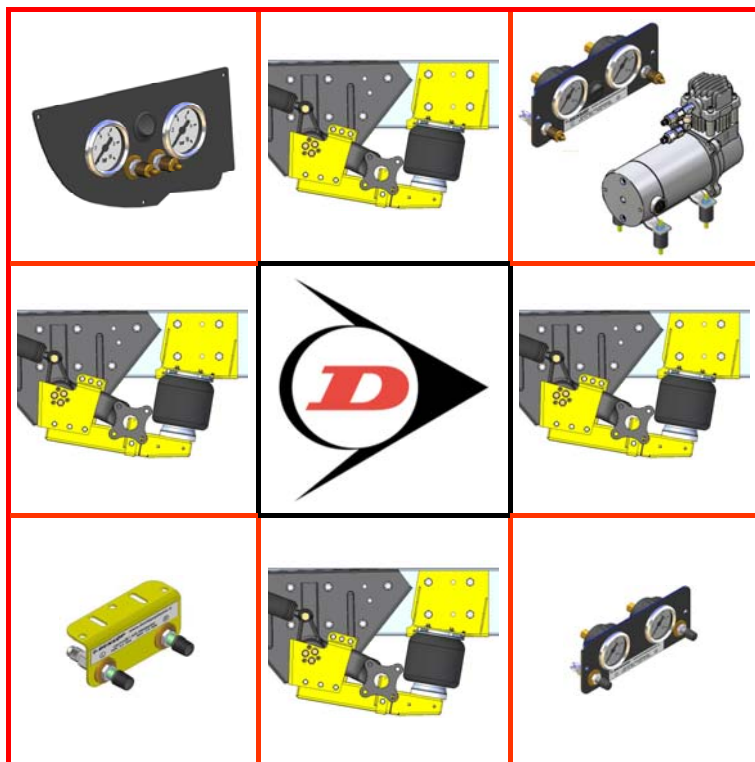

L.AL.07(C)**CONTENTS**

1.	FOREWORD.....	3
2.	VERY IMPORTANT PREREQUISITES.....	4
3.	INTRODUCTION.....	4
4.	VERY IMPORTANT NOTES.....	5
5.	CONTENTS OF THE AIR SUSPENSION KIT L.AL.07(C).....	7
5.1.	Part List.....	7
5.2.	Exploded view.....	8
6.	INSTRUCTIONS FOR INSTALLATION.....	9
6.1.	General torque recommendation.....	9
6.2.	Installing the lower brackets.....	9
6.3.	Installing the upper brackets.....	10
6.4.	Installing the air springs.....	10
6.5.	Fitting of Inflator Console.....	11
6.6.	Tube Connection and Disconnection, Cutting and Routing.....	12
6.7.	Brake modification.....	13
6.8.	Spring inflation.....	13
6.9.	Spring Alignment.....	13
6.10.	Check list.....	14
6.11.	Maintenance.....	14
7.	INSTALLATION PHOTOS.....	14
8.	EPILOGUE.....	19

DSC Nederland B.V.
Het Wegdam 22
7496 CA Hengevelde
Nederland
Tel. : +31 (0)547 333065
Fax. : +31 (0)547 333068
e-mail: info@dunlopsystems.nl
Website: www.dunlopsystems.nl

© 2017, DSC Nederland B.V.

L.AL.07(C)**1. FOREWORD**

This manual provides instructions for the installation of an auxiliary air suspension kit, developed specifically for Vehicles with an ALKO AMC single, and tandem torsion axle. Of course you need for each rear axle a kit. To ensure correct installation of the kit, it is strongly recommend that these instructions are read thoroughly before commencing any installation work. Installation should only be carried out by a suitably qualified mechanic or specialist installation facility. DSC Nederland will not accept any responsibility for faults or defects arising from incorrect installation, which automatically renders the guarantee invalid.

IMPORTANT : Manufacturer's Declaration Form

A manufacturer's declaration form is provided with your kit. Following installation of the kit please ensure that this form is completed, signed by a qualified fitter and a copy is returned to DSC Nederland by post, fax or e-mail. Our e-mail address is: info@dunlopsystems.nl

Artikel number:

**L.AL.07(C)
chassis****- Auxiliary air suspension for AIKo AMC**

Valid for:

**AMC 33L, 35LB, 35LH, 35L, 37L, 35H, 38H, 35HA, 40H, 42H,
45HT, 50HT**

L.AL.07(C)**2. VERY IMPORTANT PREREQUISITES****Check the condition of the Torsion Axle of your Vehicle**

Before attempting to fit an auxiliary air suspension system to your vehicle, it is extremely important to be aware that the torsion axle of your vehicle must be in good condition. **Please observe all of the following guidelines...**

- **Never** install air springs if there is any indication of faults within the axle assembly
- AL-AL-KO recommends a replacement of the axle every 100,000—120,000 km (62,000—75,000 miles)
- Air springs serve only to assist the torsion springs
- Observe whether the vehicle is listing significantly to one side, which would indicate a damaged or broken torsion spring
- Lift the rear of the vehicle until the lever arm rests against the bump stop and...
 - ... observe that the lever arm moves smoothly during lifting, so indicating adequate lubrication
 - ... listen in the area near to the lever during lifting, since noise may indicate a broken torsion spring. If in doubt, repeat the lift using some means of improving audibility (ideally a stethoscope if available, or alternatively a screwdriver or length of bar touching the lever at one end and an ear at the other)
 - ... lift a road wheel by hand and observe the lever arm in its housing for backlash. This should not exceed approximately 0.5mm.
- The axle has three splined torsion bars. Be aware that if the fixing points of these bars are broken, then the lever arm may dismount from its housing with the vehicle in motion!
- Try to find out whether any galling of the bearings has taken place
- Remove grease nipples and check the quality of the grease (make a point of greasing the nipples as a matter of course)

L.AL.07(C)**3. INTRODUCTION**

Thank you for choosing an auxiliary air suspension kit from the range offered by *DSC Nederland B.V.* Auxiliary air suspension is fitted in tandem with the standard steel springs of the vehicle suspension, and provides enhancements in terms of both the stability of the vehicle and the comfort of the passengers...

Vehicle Levelling

Simply by varying the air pressure in the springs, the vehicle can be levelled both front-to-rear and side-to-side. Keeping the vehicle level optimises stability, ensures correct headlamp beam distribution and reduces tyre wear arising from uneven distribution of weight.

Straight Line Stability

Straight line stability is greatly increased at higher speeds, and when subjected to buffeting from cross-winds or large overtaking vehicles

Reduced Body Roll

Body roll when cornering or negotiating roundabouts is significantly reduced.

Fatigue Reduction and Wear Compensation

Suspension fatigue is reduced, so helping to prevent leaf springs from sagging under repeated or constant loading.

Any sagging already present can be compensated-for. This is a particular benefit for motorhomes, which are always fully laden.

Ride Comfort

Air springs help to absorb shock loads from uneven road surfaces, therefore general ride quality is much improved.

4. VERY IMPORTANT NOTES**Gross Vehicle Weight (GVW)**

Air assist kits are not in themselves designed to increase the gross vehicle weight (GVW) rating of a vehicle. They do not legally allow for carriage of a load greater than the carrying capacity stated on the data plate of the vehicle.

Do not exceed the maximum load specified by the vehicle manufacturer...

- ◆ to avoid compromising passenger safety
- ◆ to prevent possible damage to the vehicle
- ◆ for legal reasons

L.AL.07(C)**Vehicle Upgrading**

Despite the above words of caution, it is possible to upgrade the weight rating of your vehicle. This must be carried-out by a specialist supplier that will...

- ◆ carry out any necessary modifications in addition to fitting the air assist kit
- ◆ complete documentation as necessary to inform the Vehicle and Operator Services Agency (VOSA) – a mandatory requirement
- ◆ supply and fit a new weight plate to replace the original plate supplied with the vehicle

This process applies to United Kingdom registered vehicles. The process in other countries may be different.

L.AL.07(C)**5. CONTENTS OF THE AIR SUSPENSION KIT L.AL.07(C)****5.1. Part list**

Number	Part Number	Description	Quantity
1	03.07.00.1.01	Upper Bracket - left	1
2	03.07.00.1.01.03	Reinforce plate	4
3	03.07.00.1.02	Upper Bracket - right	1
4	03.07.00.1.04	Lower Plate - left	1
5	03.07.00.1.04.03	Connection Plate Lower Bracket - left	1
6	03.07.00.1.04.05	Support bracket - left	1
7	03.07.00.1.05	Lower Plate - right	1
8	03.07.00.1.05.03	Connection Plate Lower Bracket - right	1
9	03.07.00.1.05.05	Support bracket -right	1
10	03.06.00.1.04.04	Plastic Disc	2
11	OP.LB.112050014	6" Air spring	2
12	DIN 933 M8 x 25	Hex Bolt	14
13	DIN 125A M8	Flat Washer	14
14	DIN 6923 M8	Flange Nut	14
15	DIN 933 M12 x 40 (10.9)	Hex Bolt	8
16	DIN 125A M12 (10.9)	Flat Washer	16
17	DIN 983 M12	Self Locking Nut	8
18	DIN 933 M6 x 20	Hex Bolt	4
19	DIN 7980 M6	Spring Washer	4
20	DIN 522 6.4 x 20 x 1.25	Fender Washer	4
21	DIN 912 M8 x 40	Imbus Bolt	2
22	DIN 127B M8	Spring Washer	2
23	DIN 125A M8	Flat Washer	2

Not in the assembly drawing

- Black (left) and blue (right) air hose
- Inflation option
- Tie wraps
- Declaration of conformity
- Installation manual

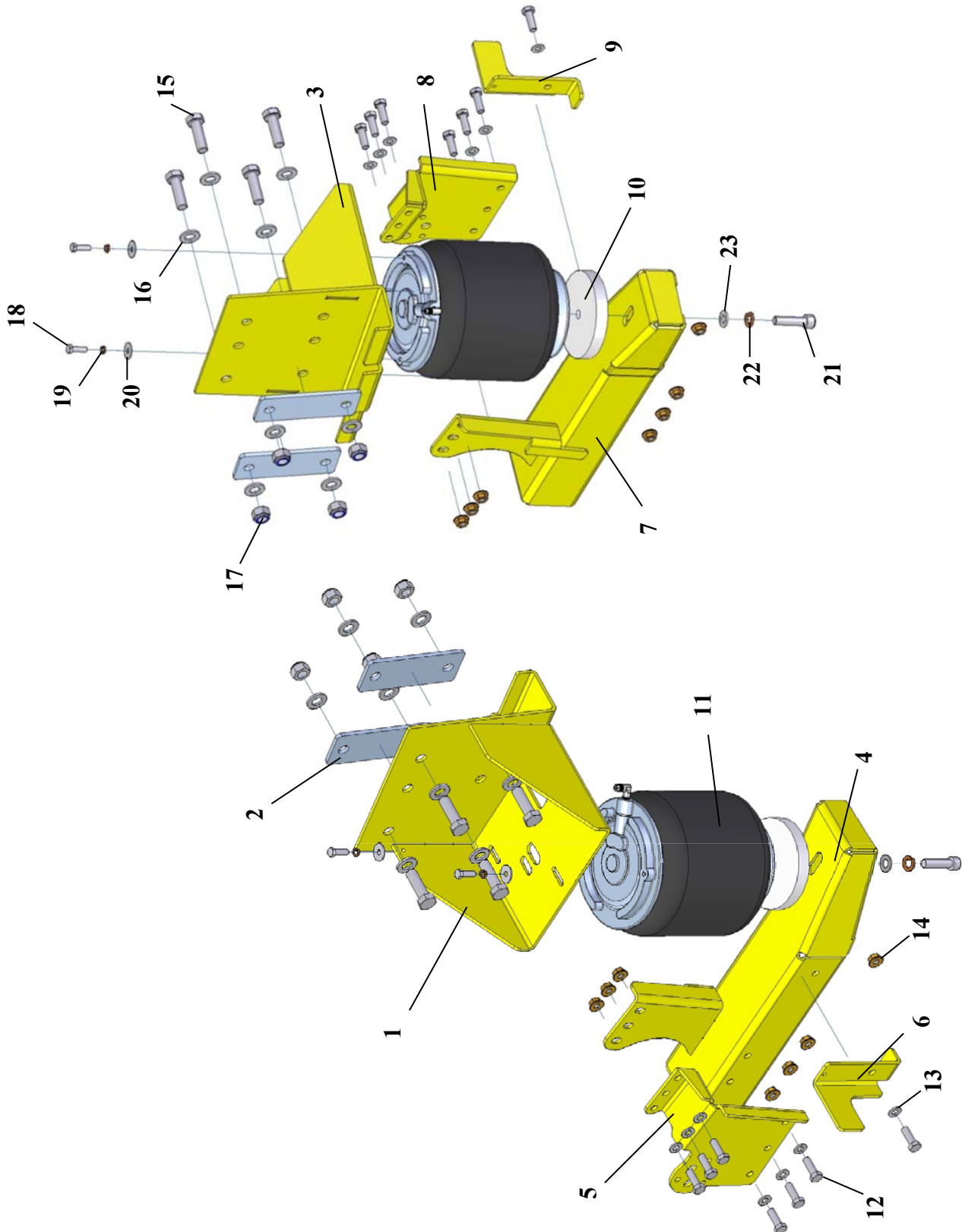
L.AL.07(C)**5.2. Exploded view**

L.AL.07(C)

6. INSTRUCTIONS FOR INSTALLATION



Preparation and Precaution



Before beginning installation, ensure that you have sufficient clearance, the wheels need to be free from the floor. Use a jack if necessary.



Pay attention to your safety at all times during installation - always use axle stands to support the vehicle!

6.1. General torque recommendation

METRIC TORQUE CHART in N.m				
SIZE	CLASS 8.8	CLASS 10.9	Aluminium	PA6G
M6 x 1	10	14	4	3
M8 x 1.25	23	34	9	6
M10 x 1.5	48	67	18	11
M12 x 1.75	83	117	31	18
M16 x 2	200	285	80	47

- When both the bolt and nut are made from steel then use column class 8.8 or 10.9.
- For the air springs of L.AL.07(C) use the column of Aluminium.
- For all other materials it is up to the discretion of the person skilled in the art.

The following instructions make reference to the diagrams on pages 16 to 19 inclusive.

6.2 Installing the lower brackets

1. Remove the three fixing bolts, that hold the torsion bars (pictures 1 and 2).
2. Remove the three M6 bolts so the cover plate can be removed. The cover plate will not be used any more.
3. Attach the connection plate of the lower bracket at this spot with the original bolts (picture 5) Don't fully tighten the bolts, it is necessarily that the plate is still able to shift in its holes.
4. Place the support bracket in the hole of the suspension arm (picture 4 and 5).
5. Now attach the lower bracket to the connection plate (pictures 6 to 10).
6. Before fully tightening the support bracket (picture 11) push the bracket downwards as far as possible.
7. Now you can tighten all the fixing bolts (picture 12)



L.AL.07(C)

6.3 Installing the upper brackets

1. In the upper bracket are 6 holes we recommend to use 4 of them. The holes we are using are positioned on a place where also AL-KO produces them for most motorhomes. Most probably there will be two holes available in the vehicle already, 2 other holes has to be drilled (picture 13).
2. Remove the 2 existing bolts and position the upper bracket. The bracket can be used as a template to drill the other 2 holes (picture 14 and 15).
3. For each side are 2 reinforce plates, both plates need to be used if 4 holes has to be drilled (picture 16).
4. The middle lip is extended with 10mm. It has to be used if a tow bar with chassis extender is involved. The other 2 lips of the upper bracket can be removed. The 2 reinforce plates together is 10 mm and will be the spacer for the other 2 bolts.
5. Secure the bracket with the included M12 x 40 bolts with washers and self locking nuts (picture 17).

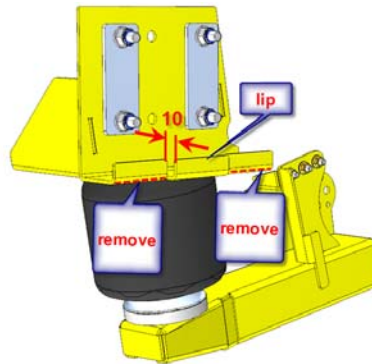

6.4 Installing the air springs

1. Attach the air spring to the upper bracket, using the M6 x 20 bolt with washers and locking ring. Do not tighten them yet (picture 17), to keep aligning of the air spring possible.
2. Connect the air hose to the air spring (see also page 10). Use black for the left side and blue for the right side. Than guide the hose along the bracket through the same hole as the ABS sensor cable to get on the inside of the chassis (picture 18 -21)
3. Put the wheels back on the vehicle and lower the vehicle till the bottom brackets almost touch the piston of the air spring.
4. Carefully inflate the air spring a bit , so the piston will touch the bottom bracket (picture 22).
5. Attach the piston and disc to the bottom bracket with the M10x 40 hexagon socket bolt with washer and locking ring. These are also not to be tightened yet (picture 18).
6. Put the vehicle in its desired right level. Align the air spring (check in both directions) and tighten the bolts on top and bottom of the air spring (picture 24).

L.AL.07(C)

6.5 Fitting of Inflator Console

Option Valves



Option 1



Option 2



Special dash board panel for Ducato X250 (option 2)

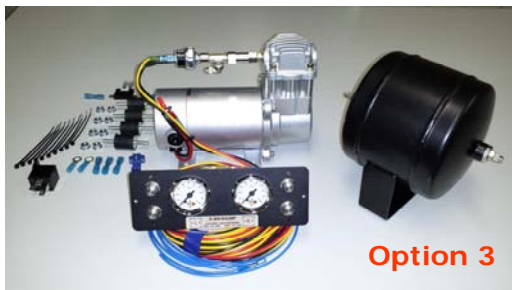

Option 3

Your kit is supplied either with the standard inflator console having two valves only (above, top-left), or an optional console having both valves and pressure gauges (Option 1 or Option 2 above). Mount the console in a position of your choice whereby it is firmly fixed, has some protection from the environment (particularly important for a console with gauges) and is easily accessible. Suggested possible locations include...

Console with Valves Only...

- on the rear bumper
- at the rear beside the license plate
- on the chassis next to a rear wheel
- in a service shutter
- beside the fuel cap

Console with Valves and Gauges...

- in the vehicle cabin, within reach and sight of the driver
- in the wall of a cupboard (motorhomes)
- in a service shutter

L.AL.07(C)

6.6 Tube Connection and Disconnection, Cutting and Routing

Connection and Disconnection

Tubes are connected as shown by the diagrams below...

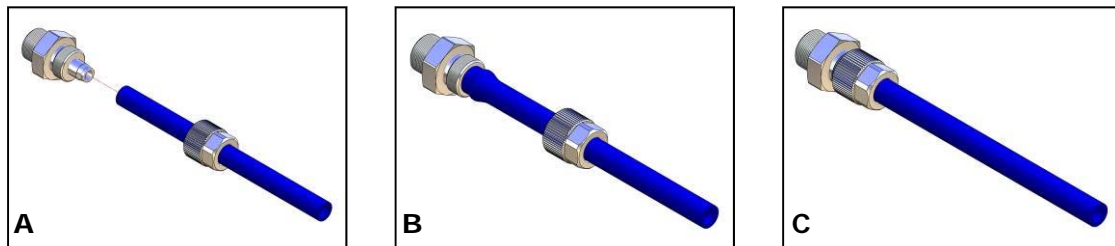

- A. Slide a nut over the end of the tube
- B. Push the hose onto the connector as far as possible
- C. Feed the nut up to the connector, fully tighten by hand and finally tighten one additional turn using spanners, take care the air hose will not twist while tightening.

Cutting

To achieve good sealing and air-tight fitting of tube ends to their connecting parts, it is very important to cut tubing cleanly and squarely. A dedicated guillotine action tubing cutter is recommended, or a craft knife if such a tool is not available. Do not use electrician's side cutters.



A dedicated tubing cutter - **Recommended**



Electrician's Side Cutters
NOT Recommended

Routing

Study the underside of the vehicle and decide how to route each branch of the air circuit...

- To minimise the risk of chafing, avoid running tubing over metal edges as much as possible. There for is a hole in the upper bracket at the rear axle side. Provide the air hose of 2 tie wraps (8 shape) one around the air hose and the other behind this tie wrap and trough the hole in the bracket
- Avoid close proximity to heat sources such as the exhaust assembly
- Choose a route that provides as much protection as possible from dirt, debris and any solid objects that may impact the underside of the vehicle

It is recommended that tubes are guided alongside brake lines as much as possible (see page 16 picture 19 –21)

L.AL.07(C)**6.7 Brake modification**

Your vehicle has ABS so there is no modification needed for your brakes.

6.8 Spring Inflation

Once installation of the air assist kit is complete, inflate the springs via the inflator console taking careful note of the following...

**Maximum and Minimum Pressure****Maximum Pressure 7.0bar****Minimum Pressure 0.5bar**

Do not exceed 7.0bar (101psi), which is the recommended maximum charge pressure for the air springs.

The springs may be deflated if the vehicle is to be stored for a lengthy period without use, but a pressure of at least 0.5bar (7.25psi) should be maintained at all times in order to avoid possible compression damage to the springs.

Test drives have resulted in an pressure of approximately 1.5—2 bar for this specific kit. Your vehicle will have a smooth drive and has raised several centimetres.

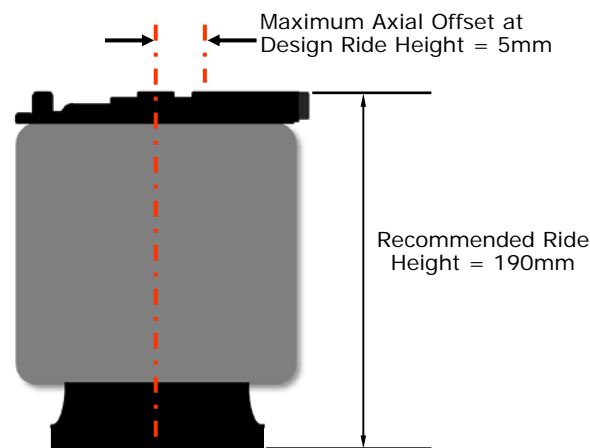
6.9 Spring Alignment**In Alignment**

The axes of the air spring top plate and piston are parallel and coaxial.

**CAUTION!**

Before tightening the bolts that connect the air spring top plate to the upper bracket and piston to the lower bracket, set the vehicle at design ride height (spring height ideally between 17.0 and 19.0cm) and ensure that the spring is as closely in alignment as possible (maximum axial offset between top plate and piston = 5 mm).

L.AL.07(C)**6.10 Check List**

Before driving the vehicle following completion of installation of the auxiliary air suspension system, please check...

- | | |
|---|--------------------------|
| ...all bolts tightened to the recommended torque (Section 6.1)? | <input type="checkbox"/> |
| ...air springs set in alignment (Section 6.9)? | <input type="checkbox"/> |
| ...enough free space around the air springs to avoid wearing? | <input type="checkbox"/> |
| ...all metal parts wax coated (Section 6.11)? | <input type="checkbox"/> |
| ...manufacturer's declaration form completed and a copy returned? | <input type="checkbox"/> |



A wait of 24 hours is recommended in order to ensure that the vehicle has maintained its stance and that there are no air leaks present.

6.11 Maintenance

Following installation, it is recommended that all metal parts are coated with a protective substance such as body wax.

The system does not require very much maintenance other than...

- ◆ to maintain air pressure in the springs. Much like a tyre, the system may lose a little air over time.
- ◆ to keep the air bellows clean. It is suggested that, when washing the vehicle, the bellows are inspected and cleaned as necessary (preferable by spraying). Look in particular for stones or grit trapped between convolutes, as this may damage the bellow.
- ◆ Check before and after the winter period the wax coating. Re-wax when necessarily.

L.AL.07(C)**7. INSTALLATION PHOTOS**

1

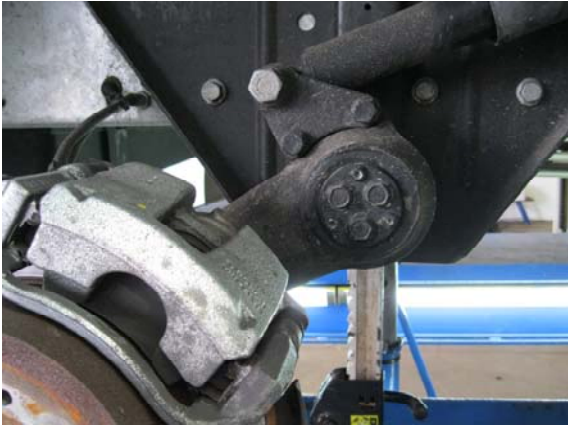

2

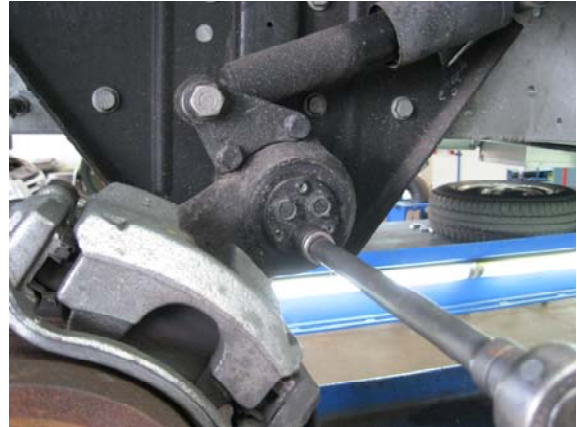

3



4



5



6



Citroën Jumper X244

Fiat Ducato X244

Peugeot Boxer X244

L.AL.07(C)

7



8



9



10



11



12



Citroën Jumper X244

Fiat Ducato X244

Peugeot Boxer X244

L.AL.07(C)

13

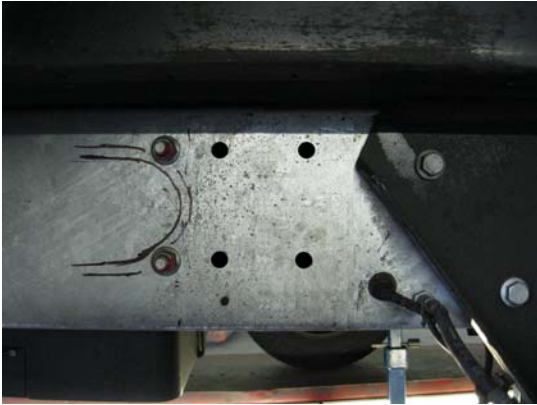

14



15

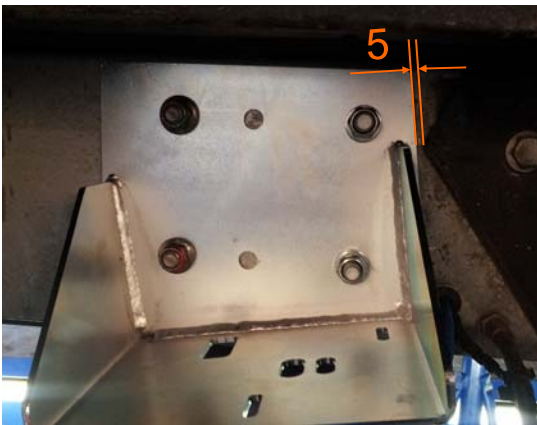

16



17



18

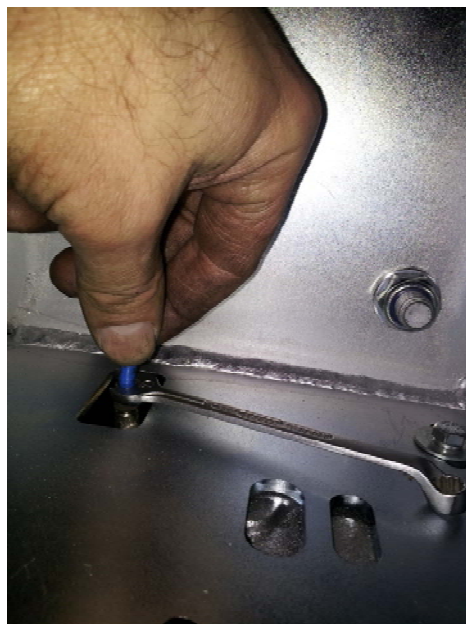

19



20



21



22



23



24



L.AL.07(C)**8. EPILOGUE**

DSC Nederland hopes that you enjoy the benefits that your *DUNLOP* air suspension system will provide for you. To ensure optimal performance, we advise that you have your system checked frequently by qualified personnel. As recommended in the fitting instructions, it is important to coat all the steel parts with a protective substance such as body wax.

IMPORTANT : Manufacturer's Declaration Form

A manufacturer's declaration form is provided with your kit. Following installation of the kit please ensure that this form is completed, signed by a qualified fitter and a copy is returned to DSC Nederland by post, fax or e-mail. Our e-mail address is: info@dunlopsystems.nl

As a condition of your warranty, modifications to the system may only be carried out by personnel of DSC Nederland.

Enquiries

For general enquiries please contact one of our dealers. You can find them on our website.

www.dunlopsystems.nl

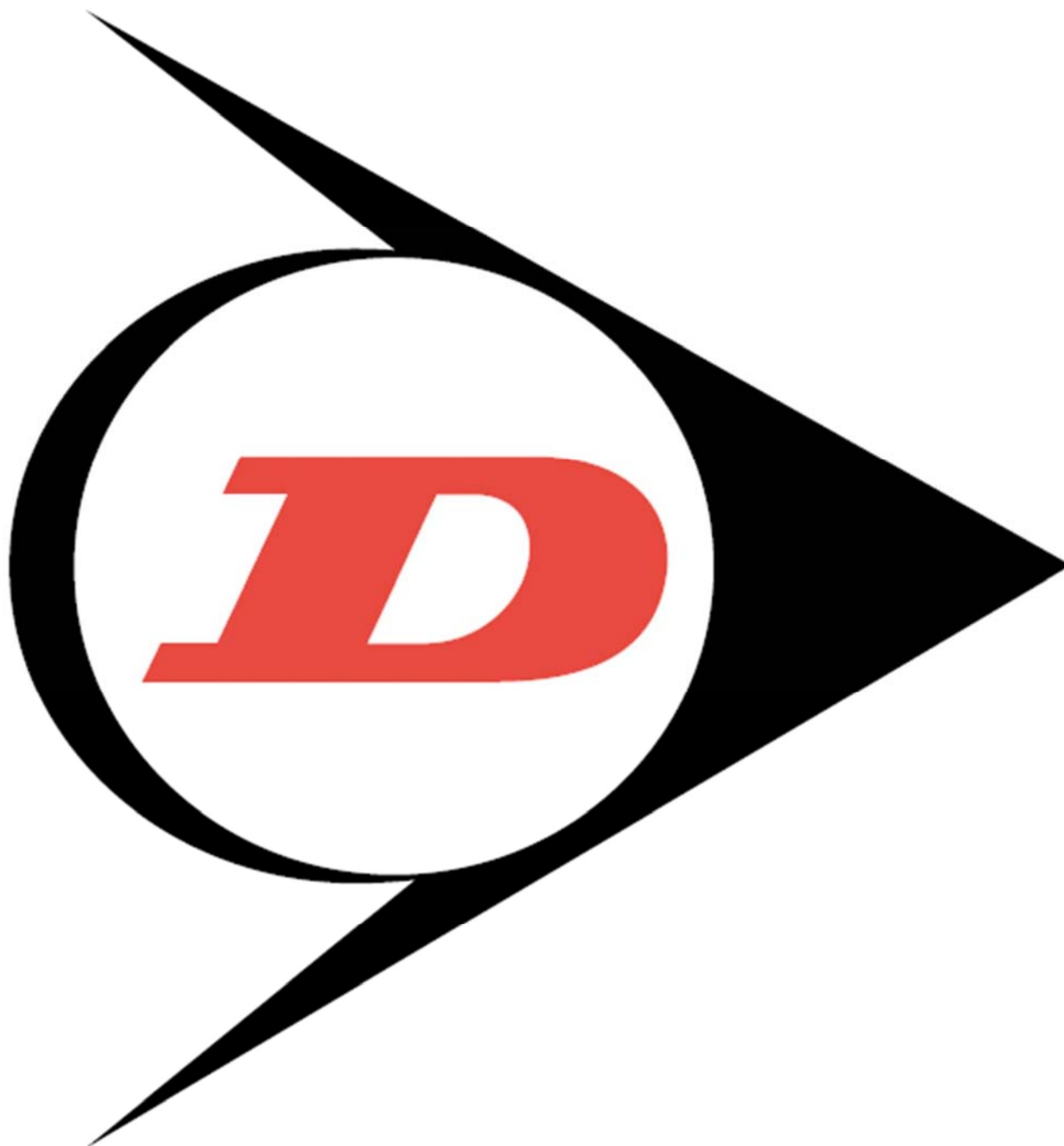

DSC Nederland B.V.
Het Wegdam 22
7496 CA Hengevelde
Nederland
Tel. : +31 (0)547 333065
Fax. : +31 (0)547 333068
e-mail: info@dunlopsystems.nl

www.dunlopsystems.nl